

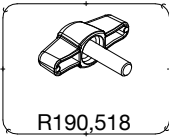

**ART. 756XB**

For serial number  
from A1588573



R190,518

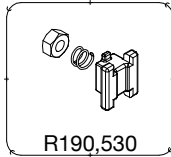

R190,530

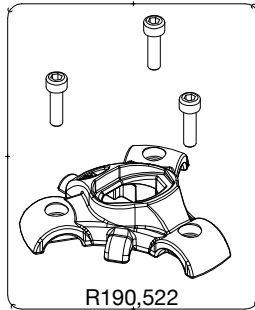

R190,522



R190,534C01

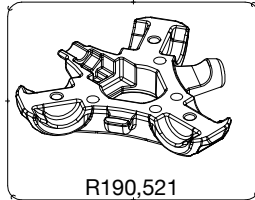

R190,521

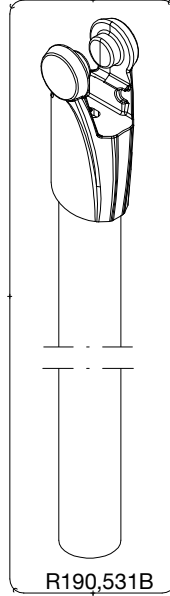

R190,531B

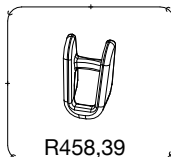

R458,39

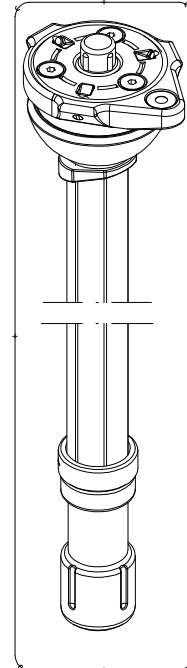

For column spare  
list see drawing:  
Art. 556B

Tool (TORX T25) included in :  
- Spare part R055,399  
- Spare part R190,499

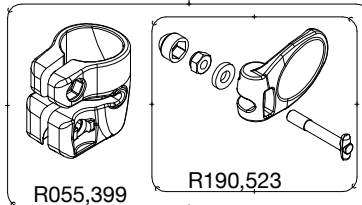

R055,399

R190,523

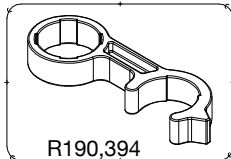

R190,394

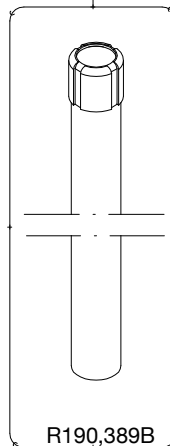

R190,389B

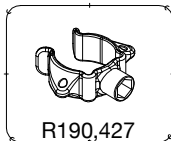

R190,427

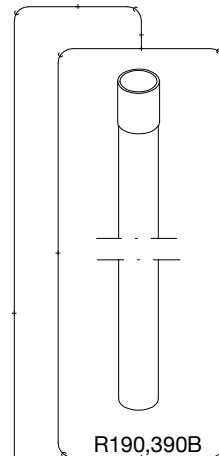

R190,390B

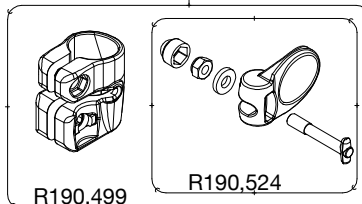
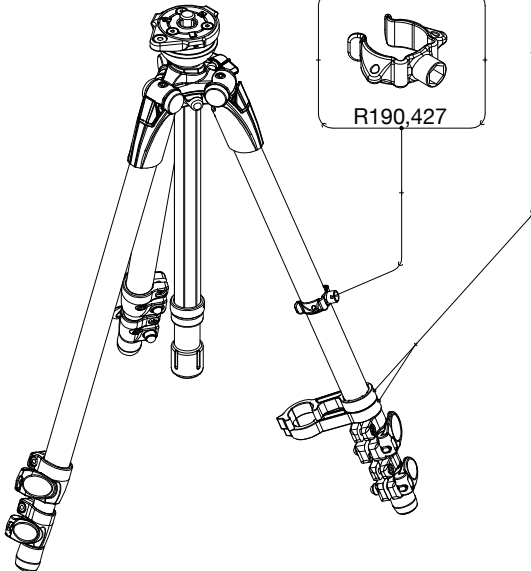

R190,499

R190,524

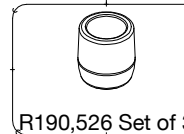

R190,526 Set of 3