

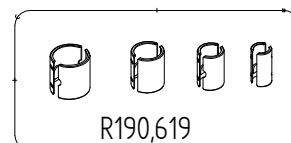

ART. 695CX

For serial number
from XXXXXX

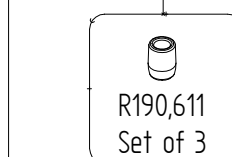
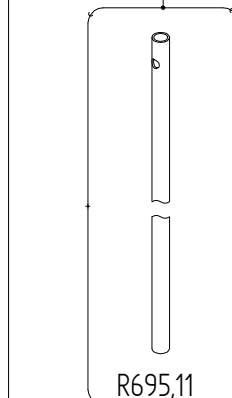
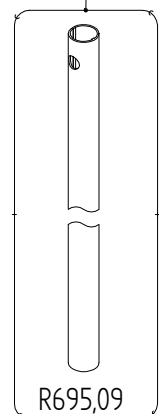
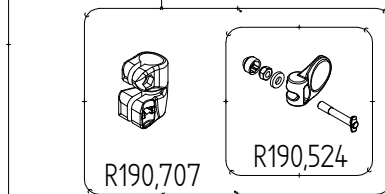
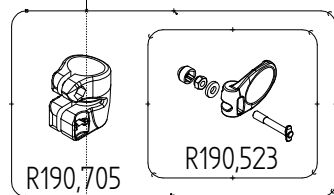
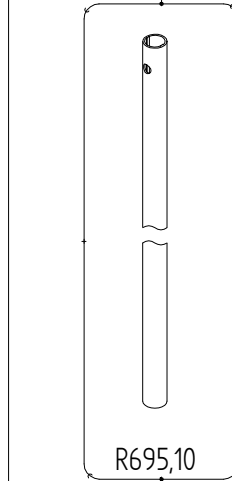
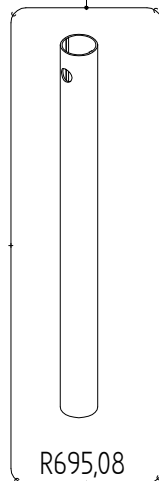
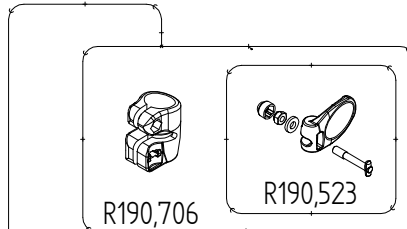
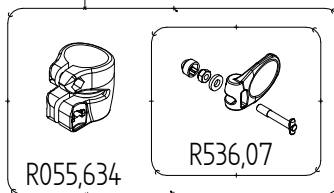
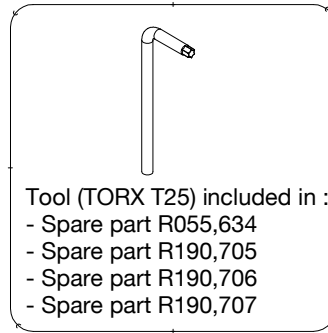
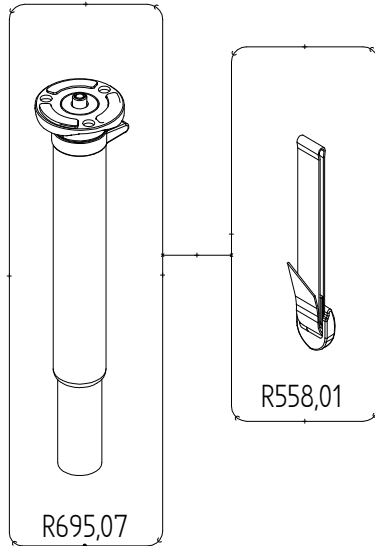

TO BE MOUNTED
ON TUBES

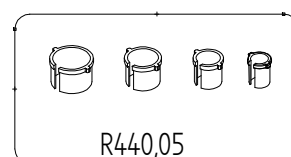

TO BE MOUNTED
ON CLAMPING-COLLARS

