

Manfrotto nord

ART.

694

For serial number
from A0010822

2004-10-22

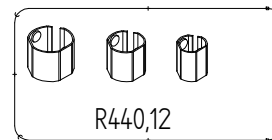
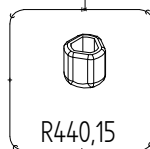
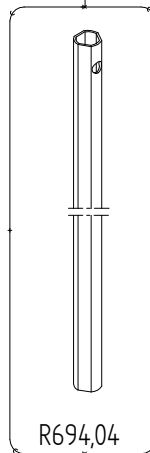
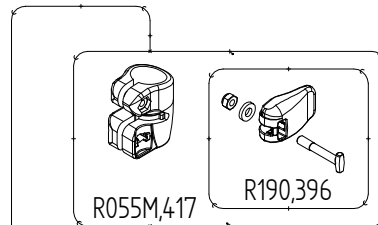
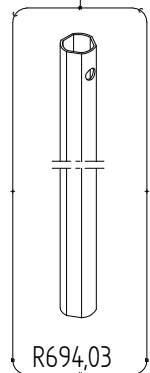
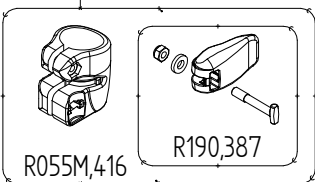
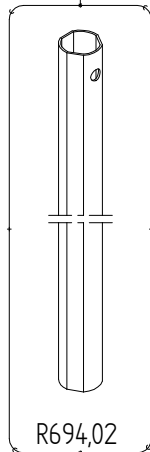
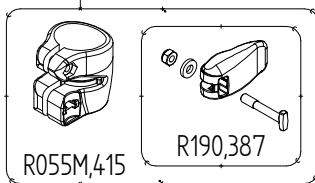
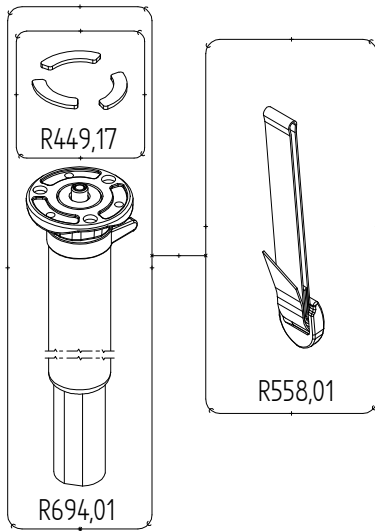

TO BE MOUNTED
ON TUBES

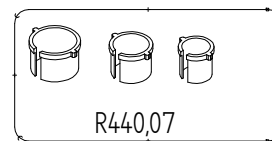

TO BE MOUNTED
ON CLAMPING-COLLARS

