

2006-03-01

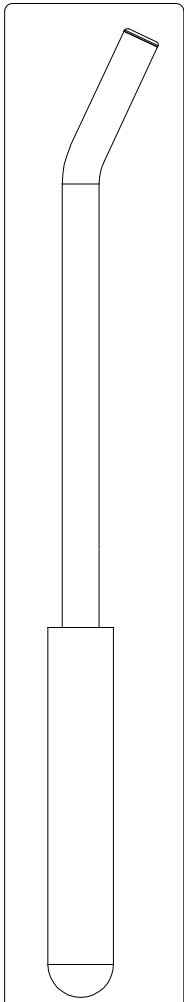

R12

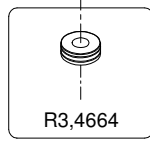
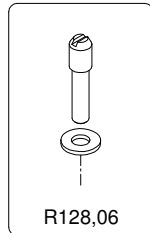
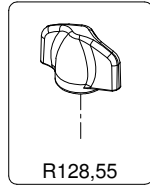
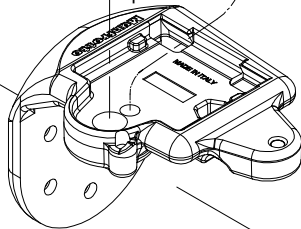
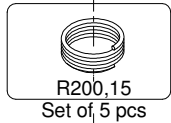
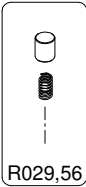
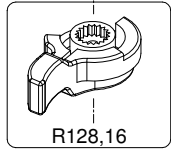
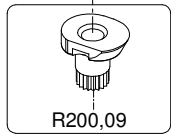
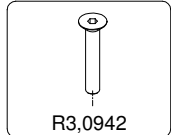
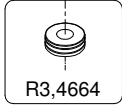
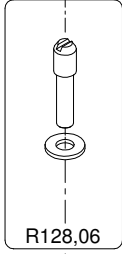
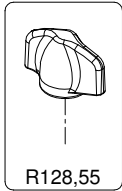

R128,77

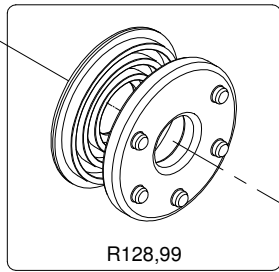

R128,99

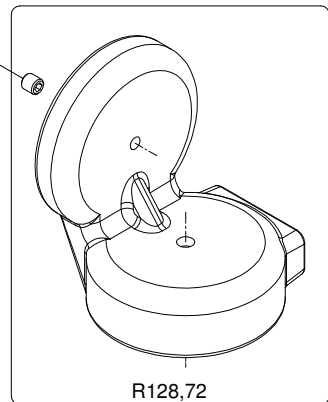
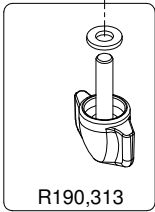
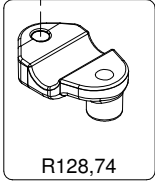

R128,72

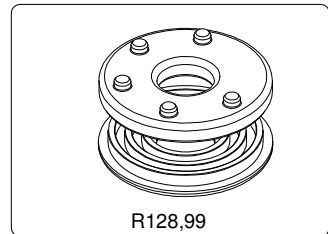

R128,99

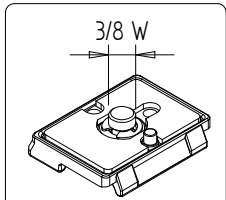

ART.200PL-38

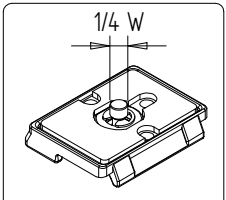

ART.200PL-14

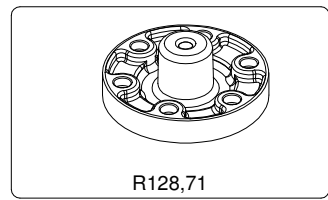

R128,71