

VERSIONE: 003
DEL: 2000-05-10

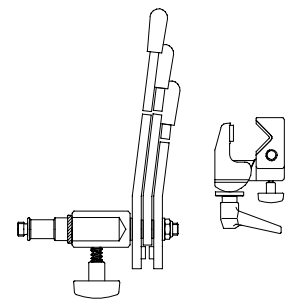
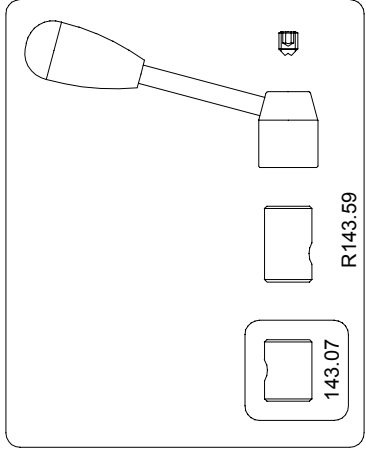
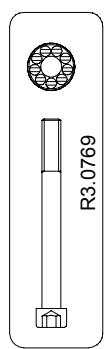
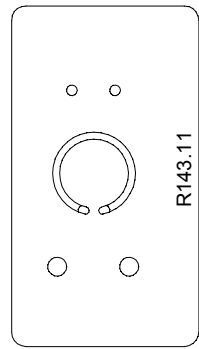
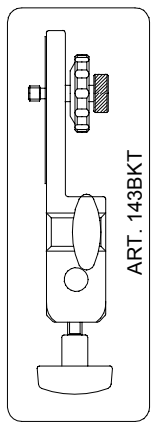
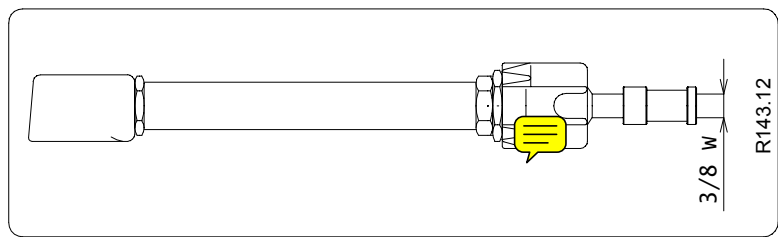
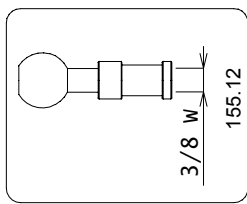
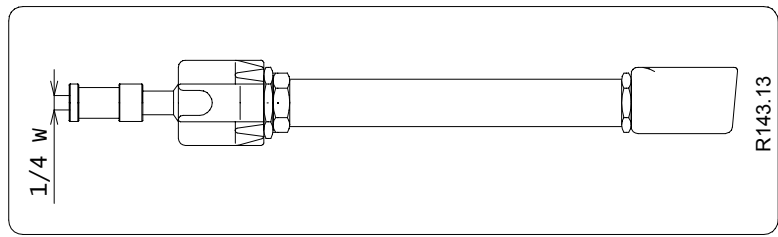
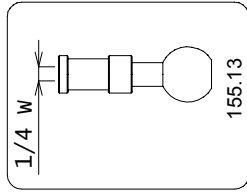
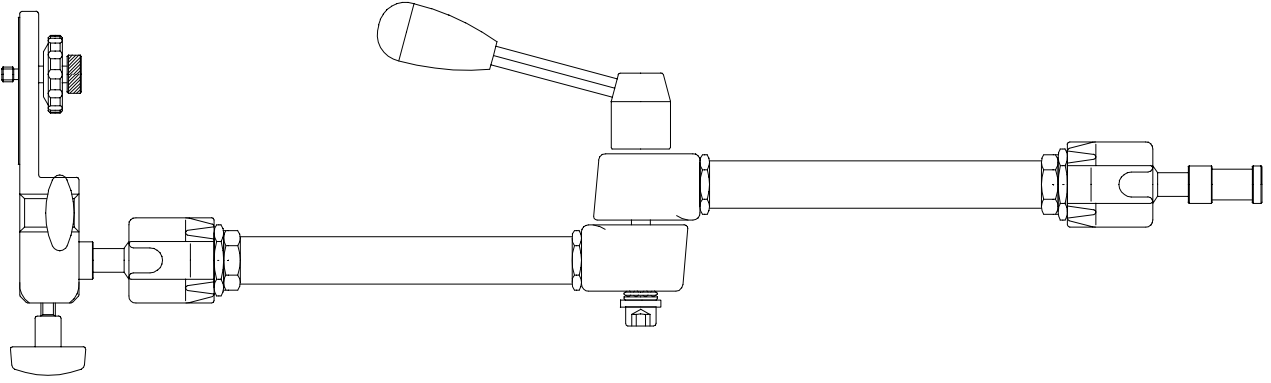

FOR BACKLITE SPARE LIST SEE DRAWING: ART.003

FOR SUPER CLAMP SPARE LIST SEE DRAWING: ART.035